

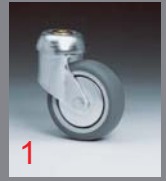

CHILDREN TROLLEY
25 L.

INFANTIL
25 L.

CODIFICACION BASICA DEL CARRO DE AUTOSERVICIO
SUPERMARKET TROLLEY CODES



BANDERA
FLAG

CON
WITH



CASCB02501
6,45 kg.

SIN
WITHOUT



CASSB02501
5,55 kg.

25 L.

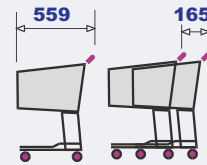
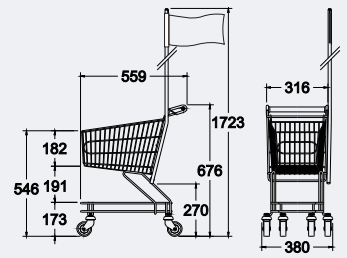

- x5** 1,22 mts.
- x10** 2,05 mts.
- x15** 2,87 mts.
- x25** 4,52 mts.



COLOR PARA CARRO
AVAILABLE PAINTED COLOURS

ORIGINAL PARA REPRODUCCION
ORIGINAL FOR CUSTOMIZED HANDLE
ORL
LOGOTIPO PARA MANGO
CUSTOMIZED HANDLE
LMC



ORIGINAL PARA REPRODUCCION "ERGOGRIP"
ORIGINAL CUSTOMIZED HANDLE FOR "ERGOGRIP"
ORL-E
LOGOTIPO PARA MANGO "ERGOGRIP"
CUSTOMIZED HANDLE FOR "ERGOGRIP"
LMC-E

EUROLOC MANGO REDONDO
EROC FOR ROUND HANDLE
MCSEURR

VARILOC
MCVH

EUROLOC MANGO OVAL
EROC FOR OVAL HANDLE
MCSEURO



SMARTLOC
MDCS

CADENA INICIAL 1 mts.
STARTING CHAIN 1 mts.
CI-S1

RAL 3011 RAL 1028 RAL 5005 RAL 7001 RAL 3020



RAL 6028 RAL 2004 RAL 1023 NEGRO-BLACK RAL 6018

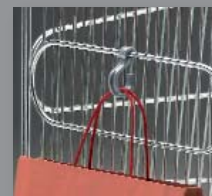

GANCHO CUELGA BOLSOS
PLASTIC BAG HOOK
GBCBA

CODIFICACION BASICA DEL CARRO DE AUTOSERVICIO
SUPERMARKET TROLLEY CODES



CASSP05001
8,50 kg.

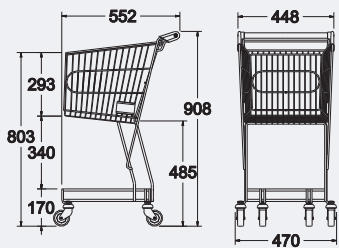

50 L.

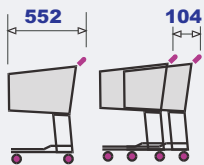

- x5** 0,97 mts.
- x10** 1,49 mts.
- x15** 2,01 mts.
- x25** 3,05 mts.



EUROLOC MANGO REDONDO
EROLOC FOR ROUND HANDLE
MCSEURR

VARILOC
MCVH

EUROLOC MANGO OVAL
EROLOC FOR OVAL HANDLE
MCSEURO

SMARTLOC
MDCS

CADENA INICIAL 1 mts.
STARTING CHAIN 1 mts.
CI-S1

ORIGINAL PARA REPRODUCCION
ORIGINAL FOR CUSTOMIZED HANDLE
ORL

LOGOTIPO PARA MANGO
CUSTOMIZED HANDLE
LMC

ORIGINAL PARA REPRODUCCION "ERGOGRIP"
ORIGINAL CUSTOMIZED HANDLE FOR "ERGOGRIP"
ORL-E

LOGOTIPO PARA MANGO "ERGOGRIP"
CUSTOMIZED HANDLE FOR "ERGOGRIP"
LMC-E

COLOR PARA CARRO
AVAILABLE PAINTED COLOURS

GANCHO CUELGA BOLSOS
PLASTIC BAG HOOK
GBCBA

RAL 3011 RAL 1028 RAL 5005 RAL 7001 RAL 3020

RAL 6028 RAL 2004 RAL 1023 NEGRO-BLACK RAL 6018

60 L.



60 L.

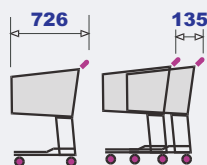
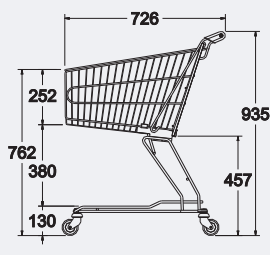

- x5** 1,27 mts.
- x10** 1,95 mts.
- x15** 2,62 mts.
- x25** 3,97 mts.

CODIFICACION BASICA DEL CARRO DE AUTOSERVICIO

SUPERMARKET TROLLEY CODES



CASSP8001
11,40 kg.

EUROLOC MANGO REDONDO
EROLOC FOR ROUND HANDLE
MCSEURR

VARILOC
MCVH

EUROLOC MANGO OVAL
EROLOC FOR OVAL HANDLE
MCSEURO



SMARTLOC
MDCS

CADENA INICIAL 1 mts.
STARTING CHAIN 1 mts.
CI-S1

ORIGINAL PARA REPRODUCCION
ORIGINAL FOR CUSTOMIZED HANDLE
ORL

LOGOTIPO PARA MANGO
CUSTOMIZED HANDLE
LMC



ORIGINAL PARA REPRODUCCION "ERGOGRIP"
ORIGINAL CUSTOMIZED HANDLE FOR "ERGOGRIP"
ORL-E

LOGOTIPO PARA MANGO "ERGOGRIP"
CUSTOMIZED HANDLE FOR "ERGOGRIP"
LMC-E

RAL 3011	RAL 1028	RAL 5005	RAL 7001	RAL 3020
				
				
RAL 6028	RAL 2004	RAL 1023	NEGRO-BLACK	RAL 6018



CONJUNTO PROTECCION CESTO
BASKET PROTECTOR SET
CPC60



CANTONERAS
CORNER PROTECTORS
CPEC



COLOR PARA CARRO
AVAILABLE PAINTED COLOURS



GANCHO CUELGA BOLSOS
PLASTIC BAG HOOK
GCBCA



SOPORTE SCANNER INDIVIDUAL
SINGLE SCANNER HOLDER
SSIND

80 L.



80 L.

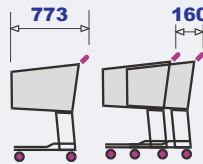
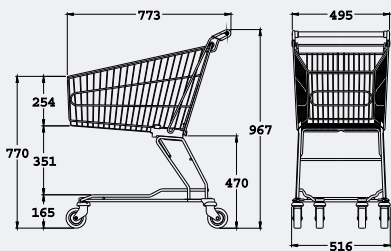

- x5** 1,41 mts.
- x10** 2,21 mts.
- x15** 3,01 mts.
- x25** 4,61 mts.

CODIFICACION BASICA DEL CARRO DE AUTOSERVICIO

SUPERMARKET TROLLEY CODES

PORTA-BEBE
BABY SEAT

SIN
WITHOUT

CON
WITH

CASSP8001
13,35 kg.

CASCP8001
14,85 kg.



CASSP8002
14,35 kg.

CASCP8002
15,85 kg.

PORTA-BEBE
BABY SEAT

CON
WITH

CON
WITH

100 L.



100 L.

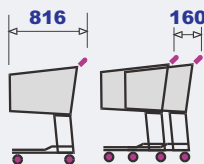
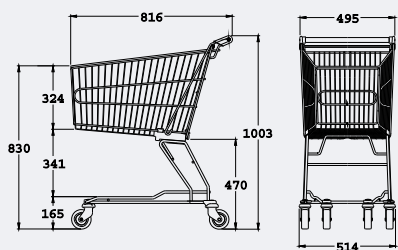

- x5** 1,46 mts.
- x10** 2,26 mts.
- x15** 3,06 mts.
- x25** 4,66 mts.

CODIFICACION BASICA DEL CARRO DE AUTOSERVICIO

SUPERMARKET TROLLEY CODES

PORTA-BEBE
BABY SEAT

SIN
WITHOUT

CASSP10002
15,35 kg.



CASCP10002
16,85 kg.

PORTA-BEBE
BABY SEAT

CON
WITH

EUROLOC MANGO REDONDO
EROLOC FOR ROUND HANDLE
MCSEURR

VARILOC
MCVH



EUROLOC MANGO OVAL
EROLOC FOR OVAL HANDLE
MCSEURO



SMARTLOC
MDCS

CADENA INICIAL 1 mts.
STARTING CHAIN 1 mts.
CI-S1



PROMOBOX MANGO REDONDO
PROMOBOX ROUND HANDLE

PMMR

PROMOBOX MANGO OVAL
PROMOBOX OVAL HANDLE

PMMO

ORIGINAL PARA REPRODUCCION
ORIGINAL FOR CUSTOMIZED HANDLE
ORL
LOGOTIPO PARA MANGO
CUSTOMIZED HANDLE
LMC



ORIGINAL PARA REPRODUCCION "ERGOGRIP"
ORIGINAL CUSTOMIZED HANDLE FOR "ERGOGRIP"

ORL-E

LOGOTIPO PARA MANGO "ERGOGRIP"
CUSTOMIZED HANDLE FOR "ERGOGRIP"
LMC-E

RAL 3011

RAL 1028

RAL 5005

RAL 7001

RAL 3020

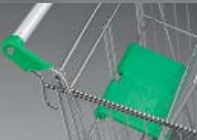

RAL 6028

RAL 2004

RAL 1023

NEGRO-BLACK

RAL 6018



SOPORTE SCANNER INDIVIDUAL
SINGLE SCANNER HOLDER

SSIND



COLOR PARA CARRO
AVAILABLE PAINTED COLOURS

REJILLA DE PLATAFORMA
GRILL BASE
RPCA100



CONJUNTO PROTECCION CESTO
BASKET PROTECTOR SET

CPC100



CANTONERAS
CORNER PROTECTORS

CPEC



PORTACARTEL PUBLICITARIO
ADVERTISEMENT HOLDER

PCPCA80160

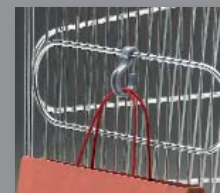

GANCHO CUELGA BOLSOS
PLASTIC BAG HOOK

GBCBA



120 L.

120 L.

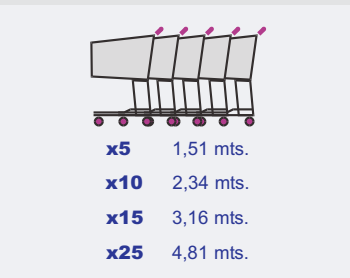
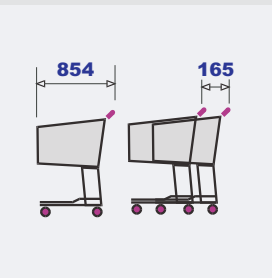
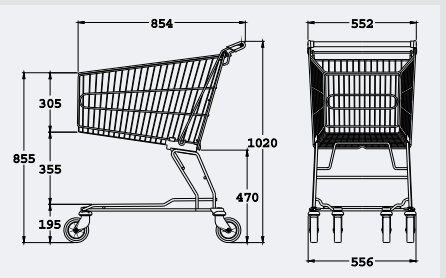

CODIFICACION BASICA DEL CARRO DE AUTOSERVICIO

SUPERMARKET TROLLEY CODES

PORTA-BEBE
BABY SEAT

SIN
WITHOUT



CON
WITH



CASSP12003
17,75 kg.



CASSP12006
17,95 kg.



CASSP12007
18,35 kg.



CASSP12008
17,75 kg.

CASCP12003
19,25 kg.

CASCP12006
19,45 kg.

CASCP12007
19,85 kg.

CASCP12008
19,25 kg.

EUROLOC MANGO REDONDO
EROLOC FOR ROUND HANDLE
MCSEURR

VARILOC
MCVH



EUROLOC MANGO OVAL
EROLOC FOR OVAL HANDLE
MCSEURO



SMARTLOC
MDCS

CADENA INICIAL 1 mts.
STARTING CHAIN 1 mts.

CI-S1



PROMOBOX MANGO REDONDO
PROMOBOX FOR ROUND HANDLE

PMMR

PROMOBOX MANGO OVAL
PROMOBOX FOR OVAL HANDLE

PMMO

ORIGINAL PARA REPRODUCCION
ORIGINAL FOR CUSTOMIZED HANDLE
ORL
LOGOTIPO PARA MANGO
CUSTOMIZED HANDLE
LMC



ORIGINAL PARA REPRODUCCION "ERGOGRIP"
ORIGINAL CUSTOMIZED HANDLE FOR "ERGOGRIP"

ORL-E

LOGOTIPO PARA MANGO "ERGOGRIP"
CUSTOMIZED HANDLE FOR "ERGOGRIP"

LMC-E

RAL 3011

RAL 1028

RAL 5005

RAL 7001

RAL 3020

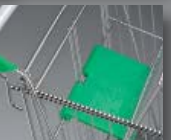
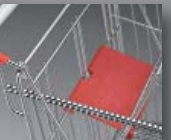

RAL 6028

RAL 2004

RAL 1023

NEGRO-BLACK

RAL 6018



SOPORTE SCANNER INDIVIDUAL
SINGLE SCANNER HOLDER

SSIND



COLOR PARA CARRO

AVAILABLE PAINTED COLOURS

REJILLA DE PLATAFORMA
GRILL BASE
RPCA120



CONJUNTO PROTECCION CESTO
BASKET PROTECTOR SET

CPC120



CANTONERAS
CORNER PROTECTORS

CPEC



PORTACARTEL PUBLICITARIO
ADVERTISEMENT HOLDER

PCPCA80160

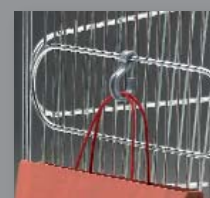

GANCHO CUELGA BOLSOS
PLASTIC BAG HOOK

GBCBA



140 L.

140 L.

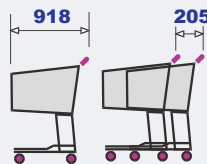
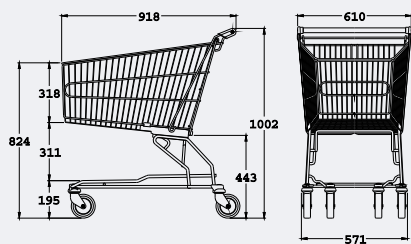

- x5** 1,74 mts.
- x10** 2,76 mts.
- x15** 3,79 mts.
- x25** 5,84 mts.

CODIFICACION BASICA DEL CARRO DE AUTOSERVICIO

SUPERMARKET TROLLEY CODES

PORTA-BEBE
BABY SEAT

SIN
WITHOUT



CON
WITH



CASSP14003
21,6 kg.



CASSP14006
21,8 kg.



CASSP14007
22,2 kg.



CASSP14008
21,6 kg.

21,6 kg.

21,8 kg.

22,2 kg.

21,6 kg.

CASCP14003
23.10 kg.

CASCP14006
23,3 kg.

CASCP14007
23,7 kg.

CASCP14008
23.10 kg.

VARILOC
MCVH



SMARTLOC
MDCS

EUROLOC MANGO REDONDO
EROLOC FOR ROUND HANDLE
MCSEURR



EUROLOC MANGO OVAL
EROLOC FOR OVAL HANDLE
MCSEURO



CADENA INICIAL 1 mts.
STARTING CHAIN 1 mts.
CI-S1



MANGO ERGOBOX ERGOBOX HANDLE
MEBM



SOPORTE SCANNER DE MANO "ERGOBOX"
SCANNER HOLDER FOR "ERGOBOX"

SSE

LUPA PLEGABLE "ERGOBOX"
MAGNIFYING GLASS

LPMEBX



PROMOBBOX MANGO REDONDO
PROMOBBOX FOR ROUND HANDLE

PMMR

PROMOBBOX MANGO OVAL
PROMOBBOX FOR OVAL HANDLE

PMMO

ORIGINAL PARA REPRODUCCION
ORIGINAL FOR CUSTOMIZED HANDLE

ORL

LOGOTIPO PARA MANGO
CUSTOMIZED HANDLE

LMC



ORIGINAL PARA REPRODUCCION "ERGOGRIP"
ORIGINAL CUSTOMIZED HANDLE FOR "ERGOGRIP"

ORL-E

LOGOTIPO PARA MANGO "ERGOGRIP"
CUSTOMIZED HANDLE FOR "ERGOGRIP"

LMC-E

RAL 3011

RAL 1028

RAL 5005

RAL 7001

RAL 3020



RAL 6028

RAL 2004

RAL 1023

NEGRO-BLACK

RAL 6018



SOPORTE SCANNER INDIVIDUAL
SINGLE SCANNER HOLDER

SSIND

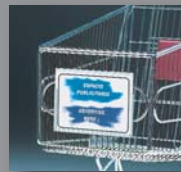

PORTACARTEL PUBLICITARIO
ADVERTISEMENT HOLDER
PCPCA80160



CUNA DE CESTO
BABY CRADLE

CCBD



PORTA-BEBE
DOBLE FUNCION

PBPDFI

DOUBLE FUNCTION
BABY SEAT



REJILLA DE PLATAFORMA
GRILL BASE

RPCA140



COLOR PARA CARRO
AVAILABLE PAINTED COLOURS



PORTA-BEBE
DOBLE FUNCION

PBPDFI

DOUBLE FUNCTION
BABY SEAT



CONJUNTO PROTECCION CESTO
BASKET PROTECTOR SET

CPC140



CANTONERAS
CORNER PROTECTORS
CPEC



SEPARADOR CESTA PEQUEÑO
BASKET DIVIDER

SPCA140



SEPARADOR CESTA
VERTICAL BASKET DIVIDER

SCA140

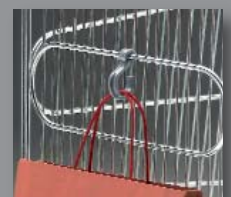

GANCHO CUELGA BOLSOS
PLASTIC BAG HOOK

GCBCA

160 L.



160 L.

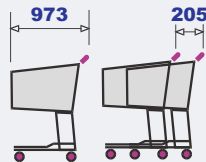
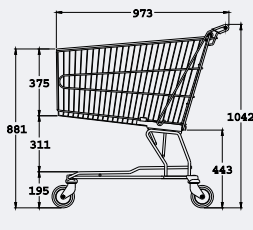

- x5** 1,79 mts.
- x10** 2,82 mts.
- x15** 3,84 mts.
- x25** 5,89 mts.

CODIFICACION BASICA DEL CARRO DE AUTOSERVICIO

SUPERMARKET TROLLEY CODES

PORTA-BEBE
BABY SEAT

SIN
WITHOUT



CON
WITH



CASSP16003
22,75 kg.



CASSP16006
22,95 kg.



CASSP16007
23,35 kg.



CASSP16008
22,75 kg.

CASCP16003
24,25 kg.

CASCP16006
24,45 kg.

CASCP16007
24,85 kg.

CASCP16008
24,25 kg.

EUROLOC MANGO REDONDO
EROLOC FOR ROUND HANDLE
MCSEURR

VARILOC
MCVH



EUROLOC MANGO OVAL
EROLOC FOR OVAL HANDLE
MCSEURO



SMARTLOC
MDCS

CADENA INICIAL 1 mts.
STARTING CHAIN 1 mts.
CI-S1



MANGO ERGOBOX ERGOBOX HANDLE
ME BM



SOPORTE SCANNER DE MANO "ERGOBOX"
SCANNER HOLDER FOR "ERGOBOX"
SSE

LUPA PLEGABLE "ERGOBOX"
MAGNIFYING GLASS
LPMEBX



PROMOBOX MANGO REDONDO
PROMOBOX FOR ROUND HANDLE
PMMR

PROMOBOX MANGO OVAL
PROMOBOX FOR OVAL HANDLE
PMMO

ORIGINAL PARA REPRODUCCION
ORIGINAL FOR CUSTOMIZED HANDLE
ORL

LOGOTIPO PARA MANGO
CUSTOMIZED HANDLE
LMC



ORIGINAL PARA REPRODUCCION "ERGOGRIIP"
ORIGINAL CUSTOMIZED HANDLE FOR "ERGOGRIIP"
ORL-E

LOGOTIPO PARA MANGO "ERGOGRIIP"
CUSTOMIZED HANDLE FOR "ERGOGRIIP"
LMC-E

RAL 3011 RAL 1028 RAL 5005 RAL 7001 RAL 3020



RAL 6028 RAL 2004 RAL 1023 NEGRO-BLACK RAL 6018



SOPORTE SCANNER INDIVIDUAL
SINGLE SCANNER HOLDER
SSIND



PORTACARTEL PUBLICITARIO
ADVERTISEMENT HOLDER
PCPCA80160



CUNA DE CESTO
BABY CRADLE
CCB



PORTA-BEBE
DOBLE FUNCION **PBP** DOBLE FUNCION
BABY SEAT



REJILLA DE PLATAFORMA
GRILL BASE
RPCA160



COLOR PARA CARRO
AVAILABLE PAINTER COLOURS



PORTA-BEBE
DOBLE FUNCION **PBPDF** DOBLE FUNCION
BABY SEAT



CONJUNTO PROTECCION CESTO
BASKET PROTECTOR SET
CPC160



CANTONERAS
CORNER PROTECTORS
CPEC



SEPARADOR CESTA PEQUEÑO
BASKET DIVIDER
SPCA160



SEPARADOR CESTA
VERTICAL BASKET DIVIDER
SCA160



GANCHO CUELGA BOLSOS
PLASTIC BAG HOOK
GBCA



180 L.

180 L.

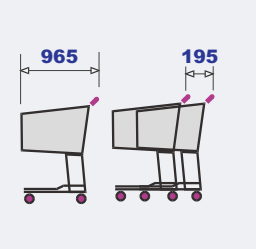
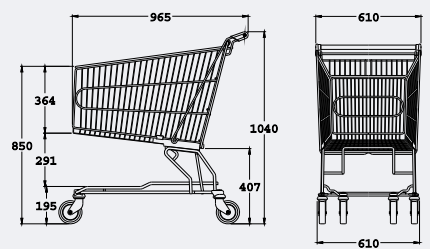

- x5** 1,74 mts.
- x10** 2,72 mts.
- x15** 3,69 mts.
- x25** 5,64 mts.

CODIFICACION BASICA DEL CARRO DE AUTOSERVICIO

SUPERMARKET TROLLEY CODES

PORTA-BEBE
BABY SEAT

SIN
WITHOUT



CON
WITH



CASSP18003
24 kg.



CASSP18006
24,2 kg.



CASSP18007
24,6 kg.



CASSP18008
24 kg.



CASCP18003
25,5 kg.



CASCP18006
25,7 kg.



CASCP18007
26,1 kg.



CASCP18008
25,5 kg.

VARILOC
MCVH



SMARTLOC
MDCS

EUROLOC MANGO REDONDO
EROLOC FOR ROUND HANDLE
MCSEURR



EUROLOC MANGO OVAL
EROLOC FOR OVAL HANDLE
MCSEURO



CADENA INICIAL 1 mts.
STARTING CHAIN 1 mts.

CI-S1



MANGO ERGOBOX ERGOBOX HANDLE
MEBM



SOPORTE SCANNER DE MANO "ERGOBOX"
SCANNER HOLDER FOR "ERGOBOX"

SSE

LUPA PLEGABLE "ERGOBOX"
MAGNIFYING GLASS

LPMEBX



PROMOBOX MANGO REDONDO
PROMOBOX FOR ROUND HANDLE

PMMR

PROMOBOX MANGO OVAL
PROMOBOX FOR OVAL HANDLE

PMMO

ORIGINAL PARA REPRODUCCION
ORIGINAL FOR CUSTOMIZED HANDLE

ORL

LOGOTIPO PARA MANGO
CUSTOMIZED HANDLE
LMC



ORIGINAL PARA REPRODUCCION "ERGOGRIIP"
ORIGINAL CUSTOMIZED HANDLE FOR "ERGOGRIIP"

ORL-E

LOGOTIPO PARA MANGO "ERGOGRIIP"
CUSTOMIZED HANDLE FOR "ERGOGRIIP"
LMC-E

RAL 3011



RAL 1028



RAL 5005



RAL 7001



RAL 3020



RAL 6028



RAL 2004



RAL 1023



NEGRO-BLACK



RAL 6018

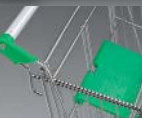

SOPORTE SCANNER INDIVIDUAL
SINGLE SCANNER HOLDER

SSIND



PORTA-BEBE
DOBLE FUNCION

BPBDFI



DOUBLE FUNCTION
BABY SEAT

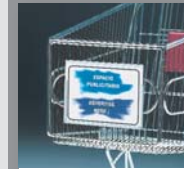

PORTACARTEL PUBLICITARIO
ADVERTISEMENT HOLDER

PCPCA180240



CUNA DE CESTO
BABY CRADLE

CCBD



REJILLA DE PLATAFORMA
GRILL BASE

RPCA180



COLOR PARA CARRO
AVAILABLE PAINTED COLOURS



DOBLE PORTA-BEBE
TWIN BABY SEAT

DPBI



CONJUNTO PROTECCION CESTO
BASKET PROTECTOR SET

CPC180



CANTONERAS
CORNER PROTECTORS

CPEC

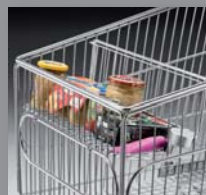

SEPARADOR CESTA PEQUEÑO
BASKET DIVIDER

SPCA180



SEPARADOR CESTA
VERTICAL BASKET DIVIDER

SCA180



GANCHO CUELGA BOLSOS
PLASTIC BAG HOOK

GCBCA



210 L.

210 L.

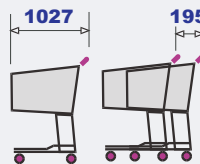
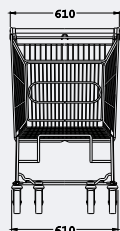
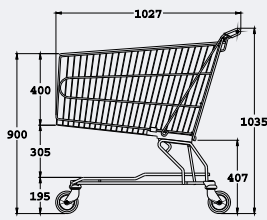

- x5** 1,81 mts.
- x10** 2,78 mts.
- x15** 3,76 mts.
- x25** 5,71 mts.

CODIFICACION BASICA DEL CARRO DE AUTOSERVICIO

SUPERMARKET TROLLEY CODES

PORTA-BEBE
BABY SEAT

SIN
WITHOUT



CON
WITH



3

CASSP21003
25,3 kg.



6

CASSP21006
25,3 kg.



7

CASSP21007
25,8 kg.



8

CASSP21008
25,3 kg.

CASCP21003
26,8 kg.

CASCP21006
26,8 kg.

CASCP21007
27,3 kg.

CASCP21008
26,8 kg.

EUROLOC MANGO REDONDO
EUROLOC FOR ROUND HANDLE
MCSEURR

VARILOC
MCVH





EUROLOC MANGO OVAL
EUROLOC FOR OVAL HANDLE
MCSEURO



SMARTLOC
MDCS

CADENA INICIAL 1 mts.
STARTING CHAIN 1 mts.
CI-S1

MANGO ERGOBOX ERGOBOX HANDLE
MEBM



SOPORTE SCANNER DE MANO "ERGOBOX"
SCANNER HOLDER FOR "ERGOBOX"
SSE

LUPA PLEGABLE "ERGOBOX"
MAGNIFYING GLASS
LPMEBX



PROMOBOX MANGO REDONDO
PROMOBOX FOR ROUND HANDLE
PMMR

PROMOBOX MANGO OVAL
PROMOBOX FOR OVAL HANDLE
PMMO

ORIGINAL PARA REPRODUCCION
ORIGINAL FOR CUSTOMIZED HANDLE
ORL

LOGOTIPO PARA MANGO
CUSTOMIZED HANDLE
LMC



ORIGINAL PARA REPRODUCCION "ERGOGRIIP"
ORIGINAL CUSTOMIZED HANDLE FOR "ERGOGRIIP"
ORL-E

LOGOTIPO PARA MANGO "ERGOGRIIP"
CUSTOMIZED HANDLE FOR "ERGOGRIIP"
LMC-E

RAL 3011 RAL 1028 RAL 5005 RAL 7001 RAL 3020



RAL 6028 RAL 2004 RAL 1023 NEGRO-BLACK RAL 6018



SOPORTE SCANNER INDIVIDUAL
SINGLE SCANNER HOLDER
SSIND



PORTA-BEBE
DOBLE FUNCION
BPDFI



DOUBLE FUNCTION
BABY SEAT



PORTACARTEL PUBLICITARIO
ADVERTISEMENT HOLDER
PCPCA180240



CUNA DE CESTO
BABY CRADLE
CCBD



REJILLA DE PLATAFORMA
GRILL BASE
RPCA210



COLOR PARA CARRO
AVAILABLE PAINTED COLOURS



DOBLE PORTA-BEBE
TWIN BABY SEAT
DPBI



CONJUNTO PROTECCION CESTO
BASKET PROTECTOR SET
CPC210



CANTONERAS
CORNER PROTECTORS
CPEC



SEPARADOR CESTA PEQUEÑO
BASKET DIVIDER
SPCA210



SEPARADOR CESTA
VERTICAL BASKET DIVIDER
SCA210



GANCHO CUELGA BOLSOS
PLASTIC BAG HOOK
GCBCA



212 L.

212 L.

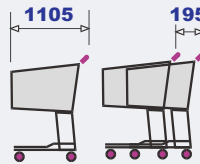
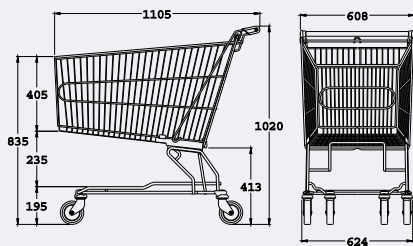

- x5** 1,88 mts.
- x10** 2,86 mts.
- x15** 3,83 mts.
- x25** 5,78 mts.

CODIFICACION BASICA DEL CARRO DE AUTOSERVICIO

SUPERMARKET TROLLEY CODES

PORTA-BEBE
BABY SEAT

SIN
WITHOUT



CON
WITH



3

CASSP21203
24,6 kg.



6

CASSP21206
24,8 kg.



7

CASSP21207
25,2 kg.



8

CASSP21208
24,6 kg.

CASCP21203
26,1 kg.

CASCP21206
26,3 kg.

CASCP21207
26,7 kg.

CASCP21208
26,1 kg.

EUROLOC MANGO REDONDO
EUROLOC FOR ROUND HANDLE
MCSEURR

VARILOC
MCVH



EUROLOC MANGO OVAL
EUROLOC FOR OVAL HANDLE
MCSEURO



SMARTLOC
MDCS

CADENA INICIAL 1 mts.
STARTING CHAIN 1 mts.
CI-S1



MANGO ERGOBOX
ERGOBOX HANDLE
ME BM



SOPORTE SCANNER DE MANO "ERGOBOX"
SCANNER HOLDER FOR "ERGOBOX"
SSE

LUPA PLEGABLE "ERGOBOX"
MAGNIFYING GLASS
LPMEBX



PROMOBOX MANGO REDONDO
PROMOBOX FOR ROUND HANDLE
PMMR

PROMOBOX MANGO OVAL
PROMOBOX FOR OVAL HANDLE
PMMO

ORIGINAL PARA REPRODUCCION
ORIGINAL FOR CUSTOMIZED HANDLE
ORL

LOGOTIPO PARA MANGO
CUSTOMIZED HANDLE
LMC



ORIGINAL PARA REPRODUCCION "ERGOGRIP"
ORIGINAL CUSTOMIZED HANDLE FOR "ERGOGRIP"
ORL-E

LOGOTIPO PARA MANGO "ERGOGRIP"
CUSTOMIZED HANDLE FOR "ERGOGRIP"
LMC-E

RAL 3011 RAL 1028 RAL 5005 RAL 7001 RAL 3020



RAL 6028 RAL 2004 RAL 1023 NEGRO-BLACK RAL 6018



SOPORTE SCANNER INDIVIDUAL
SINGLE SCANNER HOLDER
SSIND



PORTA-BEBE
DOBLE FUNCION
BPDFI



DOUBLE FUNCTION
BABY SEAT



PORTACARTEL PUBLICITARIO
ADVERTISEMENT HOLDER
PCPCA180240



CUNA DE CESTO
BABY CRADLE
CCBD



REJILLA DE PLATAFORMA
GRILL BASE
RPCA212



COLOR PARA CARRO
AVAILABLE PAINTED COLOURS



DOBLE PORTA-BEBE
TWIN BABY SEAT
DPBI



CONJUNTO PROTECCION CESTO
BASKET PROTECTOR SET
CPC212



CANTONERAS
CORNER PROTECTORS
CPEC



SEPARADOR CESTA PEQUEÑO
BASKET DIVIDER
SPCA212



SEPARADOR CESTA
VERTICAL BASKET DIVIDER
SCA212



GANCHO CUELGA BOLSOS
PLASTIC BAG HOOK
GCBCA



240 L.

240 L.

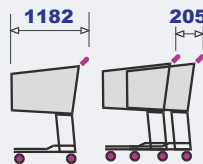
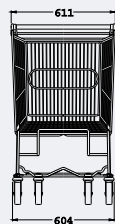
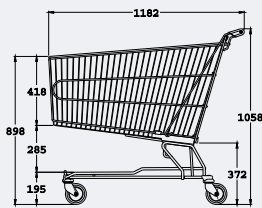

- x5** 2,00 mts.
- x10** 3,03 mts.
- x15** 4,05 mts.
- x25** 6,10 mts.

CODIFICACION BASICA DEL CARRO DE AUTOSERVICIO

SUPERMARKET TROLLEY CODES

PORTA-BEBE
BABY SEAT

SIN
WITHOUT



CON
WITH



CASSP24003
27,3 kg.



CASSP24006
27,5 kg.



CASSP24007
27,9 kg.



CASSP24008
27,3 kg.

CASCP24003
28,8 kg.

CASCP24006
29 kg.

CASCP24007
29,4 kg.

CASCP24008
28,8 kg.

EUROLOC MANGO REDONDO
EUROLOC FOR ROUND HANDLE
MCSEURR

VARILOC
MCVH



EUROLOC MANGO OVAL
EUROLOC FOR OVAL HANDLE
MCSEURO



SMARTLOC
MDCS

CADENA INICIAL 1 mts.
STARTING CHAIN 1 mts.
CI-S1



MANGO ERGOBOX
MEBM

ERGOBOX HANDLE



SOPORTE SCANNER DE MANO "ERGOBOX"
SCANNER HOLDER FOR "ERGOBOX"
SSE

LUPA PLEGABLE "ERGOBOX"
MAGNIFYING GLASS
LPMEBX



PROMOBOX MANGO REDONDO
PROMOBOX FOR ROUND HANDLE
PMMR

PROMOBOX MANGO OVAL
PROMOBOX FOR OVAL HANDLE
PMMO

ORIGINAL PARA REPRODUCCION
ORIGINAL FOR CUSTOMIZED HANDLE
ORL

LOGOTIPO PARA MANGO
CUSTOMIZED HANDLE
LMC



ORIGINAL PARA REPRODUCCION "ERGOGRIP"
ORIGINAL CUSTOMIZED HANDLE FOR "ERGOGRIP"
ORL-E

LOGOTIPO PARA MANGO "ERGOGRIP"
CUSTOMIZED HANDLE FOR "ERGOGRIP"
LMC-E

RAL 3011 RAL 1028 RAL 5005 RAL 7001 RAL 3020



RAL 6028 RAL 2004 RAL 1023 NEGRO-BLACK RAL 6018



SOPORTE SCANNER INDIVIDUAL
SINGLE SCANNER HOLDER
SSIND



PORTA-BEBE
DOBLE FUNCION
BPDFI



DOUBLE FUNCTION
BABY SEAT



PORTACARTEL PUBLICITARIO
ADVERTISEMENT HOLDER
PCPCA180240



CUNA DE CESTO
BABY CRADLE
CCBD



REJILLA DE PLATAFORMA
GRILL BASE
RPCA240



COLOR PARA CARRO
AVAILABLE PAINTED COLOURS



DOBLE PORTA-BEBE
TWIN BABY SEAT
DPBI



CONJUNTO PROTECCION CESTO
BASKET PROTECTOR SET
CPC240



CANTONERAS
CORNER PROTECTORS
CPEC



SEPARADOR CESTA PEQUEÑO
BASKET DIVIDER
SPCA240



SEPARADOR CESTA
VERTICAL BASKET DIVIDER
SCA240



GANCHO CUELGA BOLSOS
PLASTIC BAG HOOK
GBCA

80 L.



80 L.

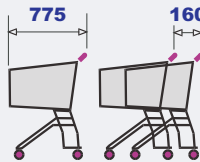
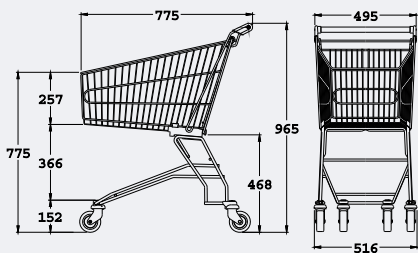

- x5** 1,42 mts.
- x10** 2,22 mts.
- x15** 3,02 mts.
- x25** 4,62 mts.

CODIFICACION BASICA DEL CARRO DE AUTOSERVICIO

SUPERMARKET TROLLEY CODES

PORTA-BEBE
BABY SEAT

SIN
WITHOUT

CON
WITH

CAASP8001
13,60 kg.

CAACP8001
16,90 kg.



CAASP8002
14,50 kg.

CAACP8002
16 kg.

PORTA-BEBE
BABY SEAT

CON
WITH

CON
WITH

EUROLOC MANGO REDONDO
EROLC FOR ROUND HANDLE
MCSEURR

VARILOC
MCVH



EUROLOC MANGO OVAL
EROLC FOR OVAL HANDLE
MCSEURO



SMARTLOC
MDCS



CADENA INICIAL 1 mts.
STARTING CHAIN 1 mts.
CI-S1



PROMOBOX MANGO REDONDO
PROMOBOX FOR ROUND HANDLE

PMMR

PROMOBOX MANGO OVAL
PROMOBOX FOR OVAL HANDLE

PMMO

ORIGINAL PARA REPRODUCCION
ORIGINAL FOR CUSTOMIZED HANDLE
ORL
LOGOTIPO PARA MANGO
CUSTOMIZED HANDLE
LMC



ORIGINAL PARA REPRODUCCION "ERGOGRIIP"
ORIGINAL CUSTOMIZED HANDLE FOR "ERGOGRIIP"

ORL-E

LOGOTIPO PARA MANGO "ERGOGRIIP"
CUSTOMIZED HANDLE FOR "ERGOGRIIP"
LMC-E

RAL 3011

RAL 1028

RAL 5005

RAL 7001

RAL 3020



RAL 6028

RAL 2004

RAL 1023

NEGRO-BLACK

RAL 6018



SOPORTE SCANNER INDIVIDUAL
SINGLE SCANNER HOLDER

SSIND



COLOR PARA CARRO

AVAILABLE PAINTED COLOURS



PORTACARTEL PUBLICITARIO
ADVERTISEMENT HOLDER

PCPCA80160



GANCHO CUELGA BOLSOS
PLASTIC BAG HOOK

GBCBA



CONJUNTO PROTECCION CESTO
BASKET PROTECTOR SET

CPC80



CANTONERAS
CORNER PROTECTORS

CPEC

100 L.



100 L.

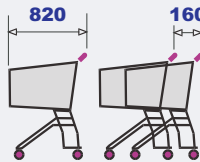
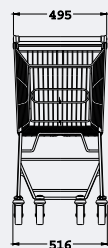
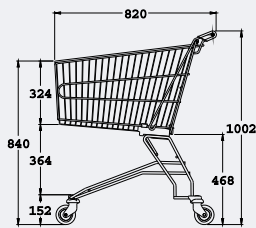

- x5** 1,46 mts.
- x10** 2,26 mts.
- x15** 3,06 mts.
- x25** 4,66 mts.

CODIFICACION BASICA DEL CARRO DE AUTOSERVICIO

SUPERMARKET TROLLEY CODES

PORTA-BEBE
BABY SEAT

SIN
WITHOUT



CAASP10002
15,55 kg.



PORTA-BEBE
BABY SEAT

CON
WITH



CAACP10002
17,05 kg.

EUROLOC MANGO REDONDO
EROLOC FOR ROUND HANDLE
MCSEURR

VARILOC
MCVH



EUROLOC MANGO OVAL
EROLOC FOR OVAL HANDLE
MCSEURO



SMARTLOC
MDCS



CADENA INICIAL 1 mts.
STARTING CHAIN 1 mts.

CI-S1



PROMOBOX MANGO REDONDO
PROMOBOX FOR ROUND HANDLE

PMMR

PROMOBOX MANGO OVAL
PROMOBOX FOR OVAL HANDLE

PMMO

ORIGINAL PARA REPRODUCCION
ORIGINAL FOR CUSTOMIZED HANDLE

ORL
LOGOTIPO PARA MANGO
CUSTOMIZED HANDLE
LMC



ORIGINAL PARA REPRODUCCION "ERGOGRIIP"
ORIGINAL CUSTOMIZED HANDLE FOR "ERGOGRIIP"

ORL-E
LOGOTIPO PARA MANGO "ERGOGRIIP"
CUSTOMIZED HANDLE FOR "ERGOGRIIP"
LMC-E

RAL 3011

RAL 1028

RAL 5005

RAL 7001

RAL 3020

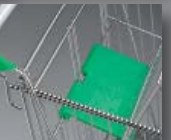
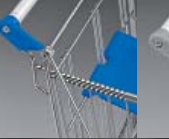

RAL 6028

RAL 2004

RAL 1023

NEGRO-BLACK

RAL 6018



SOPORTE SCANNER INDIVIDUAL
SINGLE SCANNER HOLDER

SSIND



COLOR PARA CARRO

AVAILABLE PAINTED COLOURS

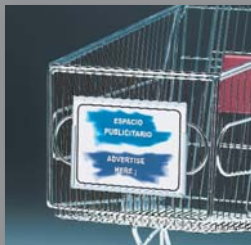

PORTACARTEL PUBLICITARIO
ADVERTISEMENT HOLDER

PCPCA80160



GANCHO CUELGA BOLSOS
PLASTIC BAG HOOK

GBCBA



CONJUNTO PROTECCION CESTO
BASKET PROTECTOR SET

CPC100



CANTONERAS
CORNER PROTECTORS

CPEC



120 L.

120 L.

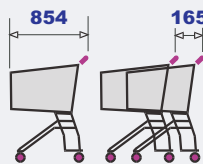
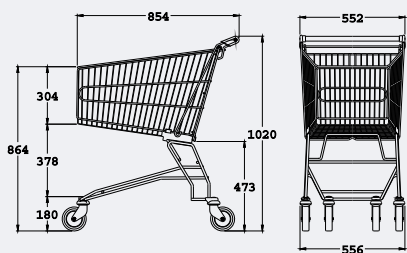

- x5** 1,51 mts.
- x10** 2,34 mts.
- x15** 3,16 mts.
- x25** 4,81 mts.

CODIFICACION BASICA DEL CARRO DE AUTOSERVICIO

SUPERMARKET TROLLEY CODES

PORTA-BEBE
BABY SEAT

SIN
WITHOUT



CON
WITH



3

CAASP12003
17,95 kg.



6

CAASP12006
18,15 kg.



7

CAASP12007
18,55 kg.



8

CAASP12008
17,95 kg.

CAACP12003
19,45 kg.

CAACP12006
19,65 kg.

CAACP12007
20,05 kg.

CAACP12008
19,45 kg.

EUROLOC MANGO REDONDO
EROLOC FOR ROUND HANDLE
MCSEURR

VARILOC
MCVH



EUROLOC MANGO OVAL
EROLOC FOR OVAL HANDLE
MCSEURO



SMARTLOC
MDCS



CADENA INICIAL 1 mts.
STARTING CHAIN 1 mts.
CI-S1



PROMOBOX MANGO REDONDO
PROMOBOX FOR ROUND HANDLE

PMMR

PROMOBOX MANGO OVAL
PROMOBOX FOR OVAL HANDLE

PMMO

ORIGINAL PARA REPRODUCCION
ORIGINAL FOR CUSTOMIZED HANDLE
ORL
LOGOTIPO PARA MANGO
CUSTOMIZED HANDLE
LMC



ORIGINAL PARA REPRODUCCION "ERGOGRIP"
ORIGINAL CUSTOMIZED HANDLE FOR "ERGOGRIP"

ORL-E

LOGOTIPO PARA MANGO "ERGOGRIP"
CUSTOMIZED HANDLE FOR "ERGOGRIP"

LMC-E

RAL 3011

RAL 1028

RAL 5005

RAL 7001

RAL 3020



RAL 6028

RAL 2004

RAL 1023

NEGRO-BLACK

RAL 6018



SOPORTE SCANNER INDIVIDUAL
SINGLE SCANNER HOLDER

SSIND



COLOR PARA CARRO
AVAILABLE PAINTED COLOURS

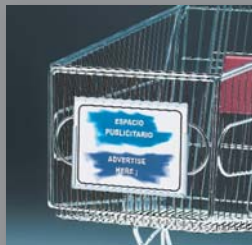

PORTACARTEL PUBLICITARIO
ADVERTISEMENT HOLDER

PCPCA80160



GANCHO CUELGA BOLSOS
PLASTIC BAG HOOK

GBCBA



CONJUNTO PROTECCION CESTO
BASKET PROTECTOR SET

CPC120



CANTONERAS
CORNER PROTECTORS

CPEC



140 L.

140 L.

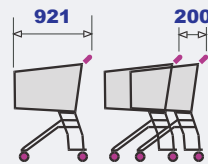
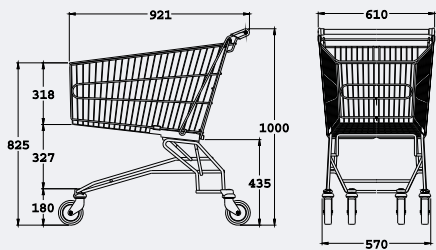

- x5** 1,72 mts.
- x10** 2,72 mts.
- x15** 3,72 mts.
- x25** 5,72 mts.

CODIFICACION BASICA DEL CARRO DE AUTOSERVICIO

SUPERMARKET TROLLEY CODES

PORTA-BEBE
BABY SEAT

SIN
WITHOUT



CON
WITH



3

CAASP14003
22,10 kg.



6

CAASP14006
22,3 kg.



7

CAASP14007
22,7 kg.



8

CAASP14008
22,10 kg.

CAACP14003
23,60 kg.

CAACP14006
23,8 kg.

CAACP14007
24,2 kg.

CAACP14008
23,60 kg.

EUROLOC MANGO REDONDO
EROLOC FOR ROUND HANDLE
MCSEURR

VARIOLOC
MCVH



EUROLOC MANGO OVAL
EROLOC FOR OVAL HANDLE
MCSEURO



SMARTLOC
MDCS

CADENA INICIAL 1 mts.
STARTING CHAIN 1 mts.
CI-S1



MANGO ERGOBOX
MEBM

ERGOBOX HANDLE



SOPORTE SCANNER DE MANO "ERGOBOX"
SCANNER HOLDER FOR "ERGOBOX"
SSE

LUPA PLEGABLE "ERGOBOX"
MAGNIFYING GLASS
LPMEBX



PROMOBOX MANGO REDONDO
PROMOBOX FOR ROUND HANDLE
PMMR

PROMOBOX MANGO OVAL
PROMOBOX FOR OVAL HANDLE
PMMO

ORIGINAL PARA REPRODUCCION
ORIGINAL FOR CUSTOMIZED HANDLE
ORL

LOGOTIPO PARA MANGO
CUSTOMIZED HANDLE
LMC



ORIGINAL PARA REPRODUCCION "ERGOGRIP"
ORIGINAL CUSTOMIZED HANDLE FOR "ERGOGRIP"
ORL-E

LOGOTIPO PARA MANGO "ERGOGRIP"
CUSTOMIZED HANDLE FOR "ERGOGRIP"
LMC-E

RAL 3011 RAL 1028 RAL 5005 RAL 7001 RAL 3020



RAL 6028 RAL 2004 RAL 1023 NEGRO-BLACK RAL 6018



SOPORTE SCANNER INDIVIDUAL
SINGLE SCANNER HOLDER
SSIND



PORTACARTEL PUBLICITARIO
ADVERTISEMENT HOLDER
PCPCA80160



CUNA DE CESTO
BABY CRADLE
CCBDB



PORTA-BEBE
DOBLE FUNCION
PBPDFI



DOUBLE FUNCTION
BABY SEAT



RACK BOTELLERO
FOLDABLE BOTTLE RACK
RB1416



COLOR PARA CARRO
AVAILABLE PAINTED COLOURS



CONJUNTO PROTECCION CESTO
BASKET PROTECTOR SET
CPC140



CANTONERAS
CORNER PROTECTORS
CPEC



SEPARADOR CESTA PEQUEÑO
BASKET DIVIDER
SPCA140



SEPARADOR CESTA
VERTICAL BASKET DIVIDER
SCA140



GANCHO CUELGA BOLSOS
PLASTIC BAG HOOK
GCBCA



160 L.

160 L.

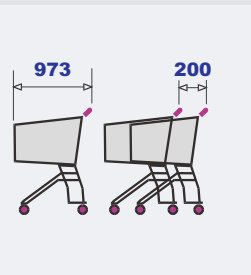
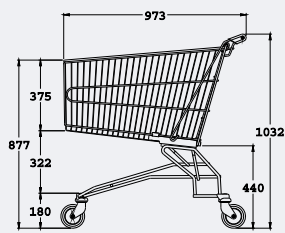

- x5** 1,77 mts.
- x10** 2,77 mts.
- x15** 3,77 mts.
- x25** 5,77 mts.

CODIFICACION BASICA DEL CARRO DE AUTOSERVICIO

SUPERMARKET TROLLEY CODES

PORTA-BEBE
BABY SEAT

SIN
WITHOUT



CON
WITH



3

CAASP16003
23,10 kg.



6

CAASP16006
22,5 kg.



7

CAASP16007
23,7 kg.



8

CAASP16008
23,10 kg.

CAACP16003
24,60 kg.

CAACP16006
24,8 kg.

CAACP16007
25,2 kg.

CAACP16008
24,60 kg.

EUROLOC MANGO REDONDO
EROLOC FOR ROUND HANDLE
MCSEURR

VARILOLOC
MCVH



EUROLOC MANGO OVAL
EROLOC FOR OVAL HANDLE
MCSEURO



SMARTLOC
MDCS

CADENA INICIAL 1 mts.
STARTING CHAIN 1 mts.
CI-S1



MANGO ERGOBOX ERGOBOX HANDLE
MEBM



SOPORTE SCANNER DE MANO "ERGOBOX"
SCANNER HOLDER FOR "ERGOBOX"
SSE

LUPA PLEGABLE "ERGOBOX"
MAGNIFYING GLASS
LPMEBX



PROMOBOX MANGO REDONDO
PROMOBOX FOR ROUND HANDLE
PMMR

PROMOBOX MANGO OVAL
PROMOBOX FOR OVAL HANDLE
PMMO

ORIGINAL PARA REPRODUCCION
ORIGINAL FOR CUSTOMIZED HANDLE
ORL

LOGOTIPO PARA MANGO
CUSTOMIZED HANDLE
LMC



ORIGINAL PARA REPRODUCCION "ERGOGRIP"
ORIGINAL CUSTOMIZED HANDLE FOR "ERGOGRIP"
ORL-E

LOGOTIPO PARA MANGO "ERGOGRIP"
CUSTOMIZED HANDLE FOR "ERGOGRIP"
LMC-E

RAL 3011 RAL 1028 RAL 5005 RAL 7001 RAL 3020



RAL 6028 RAL 2004 RAL 1023 NEGRO-BLACK RAL 6018



SOPORTE SCANNER INDIVIDUAL
SINGLE SCANNER HOLDER
SSIND



PORTACARTEL PUBLICITARIO
ADVERTISEMENT HOLDER
PCPCA80160



CUNA DE CESTO
BABY CRADLE
CCBD



PORTA-BEBE
DOBLE FUNCION
PBPDFI



DOUBLE FUNCTION
BABY SEAT



RACK BOTELLERO
FOLDABLE BOTTLE RACK
RB1416

COLOR PARA CARRO
AVAILABLE PAINTED COLOURS



CONJUNTO PROTECCION CESTO
BASKET PROTECTOR SET
CPC160



CANTONERAS
CORNER PROTECTORS
CPEC



SEPARADOR CESTA PEQUEÑO
BASKET DIVIDER
SPCA160



SEPARADOR CESTA
VERTICAL BASKET DIVIDER
SCA160



GANCHO CUELGA BOLSOS
PLASTIC BAG HOOK
GCBCA



180 L.

180 L.

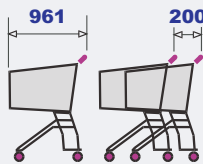
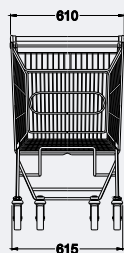

- x5** 1,76mts.
- x10** 2,76 mts.
- x15** 3,76 mts.
- x25** 5,76 mts.

CODIFICACION BASICA DEL CARRO DE AUTOSERVICIO

SUPERMARKET TROLLEY CODES

PORTA-BEBE
BABY SEAT

SIN
WITHOUT



CON
WITH



3

CAASP18003
23,6 kg.



6

CAASP18006
23,8 kg.



7

CAASP18007
24,2 kg.



8

CAASP18008
23,6 kg.

CAACP16003
25.10 kg.

CAACP18006
25,3 kg.

CAACP18007
25,7 kg.

CAACP18008
25.10 kg.

EUROLOC MANGO REDONDO
EUROLOC FOR ROUND HANDLE
MCSEURR

VARILOC
MCVH



EUROLOC MANGO OVAL
EUROLOC FOR OVAL HANDLE
MCSEURO



SMARTLOC
MDCS

CADENA INICIAL 1 mts.
STARTING CHAIN 1 mts.
CI-S1



MANGO ERGOBOX ERGOBOX HANDLE
MEBM



SOPORTE SCANNER DE MANO "ERGOBOX"
SCANNER HOLDER FOR "ERGOBOX"
SSE

LUPA PLEGABLE "ERGOBOX"
MAGNIFYING GLASS
LPMEBX



PROMOBOX MANGO REDONDO
PROMOBOX FOR ROUND HANDLE
PMMR

PROMOBOX MANGO OVAL
PROMOBOX FOR OVAL HANDLE
PMMO

ORIGINAL PARA REPRODUCCION
ORIGINAL FOR CUSTOMIZED HANDLE
ORL

LOGOTIPO PARA MANGO
CUSTOMIZED HANDLE
LMC



ORIGINAL PARA REPRODUCCION "ERGOGRIP"
ORIGINAL CUSTOMIZED HANDLE FOR "ERGOGRIP"
ORL-E

LOGOTIPO PARA MANGO "ERGOGRIP"
CUSTOMIZED HANDLE FOR "ERGOGRIP"
LMC-E

RAL 3011 RAL 1028 RAL 5005 RAL 7001 RAL 3020



RAL 6028 RAL 2004 RAL 1023 NEGRO-BLACK RAL 6018



SOPORTE SCANNER INDIVIDUAL
SINGLE SCANNER HOLDER
SSIND



PORTACARTEL PUBLICITARIO
ADVERTISEMENT HOLDER
PCPCA180240



CUNA DE CESTO
BABY CRADLE
CCBDB



PORTA-BEBE
DOBLE FUNCION
PBPDFI



DOUBLE FUNCTION
BABY SEAT



RACK BOTELLERO PLEGABLE
FOLDABLE BOTTLE RACK
RB1821



RACK BOTELLERO FIJO
FIXED BOTTLE RACK
RBF1821



COLOR PARA CARRO
AVAILABLE PAINTED COLOURS



CONJUNTO PROTECCION CESTO
BASKET PROTECTOR SET
CPC180



CONJUNTO PROTECCION CESTO
BASKET PROTECTOR SET
CPC180



CANTONERAS
CORNER PROTECTORS
CPEC



SEPARADOR CESTA PEQUEÑO
BASKET DIVIDER
SPCA180



SEPARADOR CESTA
VERTICAL BASKET DIVIDER
SCA180



GANCHO CUELGA BOLSOS
PLASTIC BAG HOOK
GCBCA



210 L.

210 L.

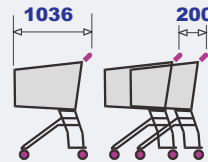
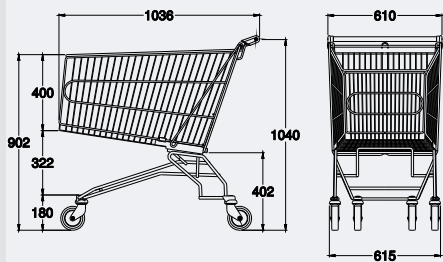

- x5** 1,83 mts.
- x10** 2,83 mts.
- x15** 3,83 mts.
- x25** 5,83 mts.

CODIFICACION BASICA DEL CARRO DE AUTOSERVICIO

SUPERMARKET TROLLEY CODES

PORTA-BEBE
BABY SEAT

SIN
WITHOUT



CON
WITH



3

CAASP21003
24,70 kg.



6

CAASP21006
24,9 kg.



7

CAASP21007
25,3 kg.



8

CAASP21008
24,70 kg.

CAACP21003
26,20 kg.

CAACP21006
26,4 kg.

CAACP21007
26,8 kg.

CAACP21008
26,20 kg.

EUROLOC MANGO REDONDO
EUROLOC FOR ROUND HANDLE
MCSEURR

VARILOC
MCVH



EUROLOC MANGO OVAL
EUROLOC FOR OVAL HANDLE
MCSEURO



SMARTLOC
MDCS

CADENA INICIAL 1 mts.
STARTING CHAIN 1 mts.
CI-S1



MANGO ERGOBOX ERGOBOX HANDLE
MEBM



SOPORTE SCANNER DE MANO "ERGOBOX"
SCANNER HOLDER FOR "ERGOBOX"
SSE

LUPA PLEGABLE "ERGOBOX"
MAGNIFYING GLASS
LPMEBX



PROMOBOX MANGO REDONDO
PROMOBOX FOR ROUND HANDLE
PMMR

PROMOBOX MANGO OVAL
PROMOBOX FOR OVAL HANDLE
PMMO

ORIGINAL PARA REPRODUCCION
ORIGINAL FOR CUSTOMIZED HANDLE
ORL

LOGOTIPO PARA MANGO
CUSTOMIZED HANDLE
LMC



ORIGINAL PARA REPRODUCCION "ERGOGRIP"
ORIGINAL CUSTOMIZED HANDLE FOR "ERGOGRIP"
ORL-E

LOGOTIPO PARA MANGO "ERGOGRIP"
CUSTOMIZED HANDLE FOR "ERGOGRIP"
LMC-E

RAL 3011 RAL 1028 RAL 5005 RAL 7001 RAL 3020



RAL 6028 RAL 2004 RAL 1023 NEGRO-BLACK RAL 6018

SOPORTE SCANNER INDIVIDUAL
SINGLE SCANNER HOLDER
SSIND



PORTACARTEL PUBLICITARIO
ADVERTISEMENT HOLDER
PCPCA180240



CUNA DE CESTO
BABY CRADLE
CCBDB



PORTA-BEBE
DOBLE FUNCION
PBPDFI



DOUBLE FUNCTION
BABY SEAT



RACK BOTELLERO PLEGABLE
FOLDABLE BOTTLE RACK FOLDING
RB1821



RACK BOTELLERO FIJO
FIXED BOTTLE RACK
RBF1821

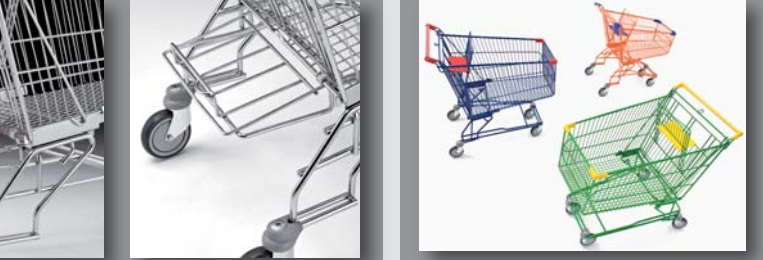

COLOR PARA CARRO
AVAILABLE PAINTED COLOURS



CONJUNTO PROTECCION CESTO
BASKET PROTECTOR SET
CPC210



CANTONERAS
CORNER PROTECTORS
CPEC



SEPARADOR CESTA PEQUEÑO
BASKET DIVIDER
SPCA210



SEPARADOR CESTA
VERTICAL BASKET DIVIDER
SCA210



GANCHO CUELGA BOLSOS
PLASTIC BAG HOOK
GCBCA



212 L.

212 L.

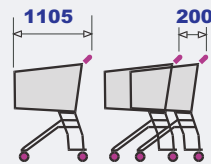
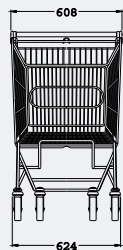
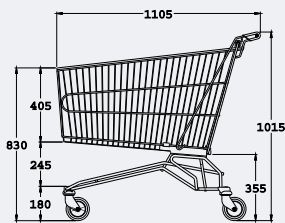

- x5** 1,91 mts.
- x10** 2,91 mts.
- x15** 3,91 mts.
- x25** 5,91 mts.

CODIFICACION BASICA DEL CARRO DE AUTOSERVICIO

SUPERMARKET TROLLEY CODES

PORTA-BEBE
BABY SEAT

SIN
WITHOUT



CON
WITH



CAASP21203
25,05 kg.



CAASP21206
25,25 kg.



CAASP21207
25,65 kg.



CAASP21208
25,05 kg.

CAACP21203
26,55 kg.

CAACP21206
26,75 kg.

CAACP21207
27,15 kg.

CAACP21208
26,55 kg.

EUROLOC MANGO REDONDO
EROLOC FOR ROUND HANDLE
MCSEURR

VARILOC
MCVH



EUROLOC MANGO OVAL
EROLOC FOR OVAL HANDLE
MCSEURO



SMARTLOC
MDCS



CADENA INICIAL 1 mts.
STARTING CHAIN 1 mts.
CI-S1



MANGO ERGOBOX ERGOBOX HANDLE
MEBM



SOPORTE SCANNER DE MANO "ERGOBOX"
SCANNER HOLDER FOR "ERGOBOX"
SSE

LUPA PLEGABLE "ERGOBOX"
MAGNIFYING GLASS
LPMEBX



PROMOBOX MANGO REDONDO
PROMOBOX FOR ROUND HANDLE
PMMR

PROMOBOX MANGO OVAL
PROMOBOX FOR OVAL HANDLE
PMMO

ORIGINAL PARA REPRODUCCION
ORIGINAL FOR CUSTOMIZED HANDLE
ORL

LOGOTIPO PARA MANGO
CUSTOMIZED HANDLE
LMC



ORIGINAL PARA REPRODUCCION "ERGOGRIP"
ORIGINAL CUSTOMIZED HANDLE FOR "ERGOGRIP"
ORL-E

LOGOTIPO PARA MANGO "ERGOGRIP"
CUSTOMIZED HANDLE FOR "ERGOGRIP"
LMC-E

RAL 3011 RAL 1028 RAL 5005 RAL 7001 RAL 3020







RAL 6028 RAL 2004 RAL 1023 NEGRO-BLACK RAL 6018





SOPORTE SCANNER INDIVIDUAL
SINGLE SCANNER HOLDER
SSIND



PORTACARTEL PUBLICITARIO
ADVERTISEMENT HOLDER
PCPCA180240



CUNA DE CESTO
BABY CRADLE
CCBD



PORTA-BEBE
DOBLE FUNCION
PBPDFI



DOUBLE FUNCTION
BABY SEAT



RACK BOTELLERO PLEGABLE
FOLDABLE BOTTLE RACK
RB1821



RACK BOTELLERO FIJO
FIXED BOTTLE RACK
RBF1821



COLOR PARA CARRO
AVAILABLE PAINTED COLOURS



CONJUNTO PROTECCION CESTO
BASKET PROTECTOR SET
CPC212



CANTONERAS
CORNER PROTECTORS
CPEC



SEPARADOR CESTA PEQUEÑO
BASKET DIVIDER
SPCA212



SEPARADOR CESTA VERTICAL
BASKET DIVIDER
SCA212



GANCHO CUELGA BOLSOS
PLASTIC BAG HOOK
GCBCA



240 L.

240 L.

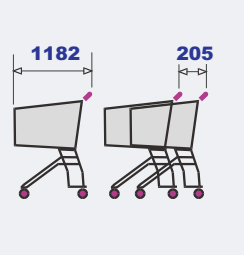
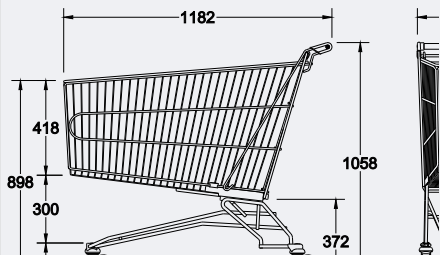

- x5** 2,00 mts.
- x10** 3,03 mts.
- x15** 4,05 mts.
- x25** 6,10 mts.

CODIFICACION BASICA DEL CARRO DE AUTOSERVICIO

SUPERMARKET TROLLEY CODES

PORTA-BEBE
BABY SEAT

SIN
WITHOUT



CON
WITH



3

CAASP24003
27,75 kg.



6

CAASP24006
27,95 kg.



7

CAASP24007
28,35 kg.



8

CAASP24008
27,75 kg.

CAACP24003
29,25 kg.

CAACP24006
29,45 kg.

CAACP24007
29,85 kg.

CAACP24008
29,25 kg.

VARILOC
MCVH



SMARTLOC
MDCS

EUROLOC MANGO REDONDO
EROLOC FOR ROUND HANDLE
MCSEURR



EUROLOC MANGO OVAL
EROLOC FOR OVAL HANDLE
MCSEURO



CADENA INICIAL 1 mts.
STARTING CHAIN 1 mts.

CI-S1



MANGO ERGOBOX ERGOBOX HANDLE
MEBM



SOPORTE SCANNER DE MANO "ERGOBOX"
SCANNER HOLDER FOR "ERGOBOX"

SSE

LUPA PLEGABLE "ERGOBOX"
MAGNIFYING GLASS

LPMEBX



PROMOBOX MANGO REDONDO
PROMOBOX FOR ROUND HANDLE

PMMR

PROMOBOX MANGO OVAL
PROMOBOX FOR OVAL HANDLE

PMMO

ORIGINAL PARA REPRODUCCION
ORIGINAL FOR CUSTOMIZED HANDLE

ORL

LOGOTIPO PARA MANGO
CUSTOMIZED HANDLE

LMC



ORIGINAL PARA REPRODUCCION "ERGOGRIP"
ORIGINAL CUSTOMIZED HANDLE FOR "ERGOGRIP"

ORL-E

LOGOTIPO PARA MANGO "ERGOGRIP"
CUSTOMIZED HANDLE FOR "ERGOGRIP"

LMC-E

RAL 3011

RAL 1028

RAL 5005

RAL 7001

RAL 3020



RAL 6028

RAL 2004

RAL 1023

NEGRO-BLACK

RAL 6018



SOPORTE SCANNER INDIVIDUAL
SINGLE SCANNER HOLDER

SSIND



CUNA DE CESTO
BABY CRADLE

CCBD



COLOR PARA CARRO

AVAILABLE
PAINTED COLOURS

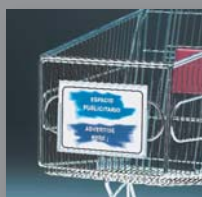

PORTACARTEL PUBLICITARIO
ADVERTISEMENT HOLDER

PCPCA180240



PORTA-BEBE
DOBLE FUNCION

PBPDFI

DOUBLE FUNCTION
BABY SEAT



CONJUNTO PROTECCION CESTO
BASKET PROTECTOR SET

CPC240



CANTONERAS
CORNER PROTECTORS

CPEC

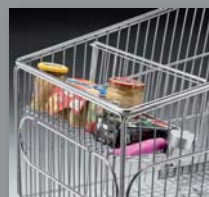

SEPARADOR CESTA PEQUEÑO
BASKET DIVIDER

SPCA240



SEPARADOR CESTA
VERTICAL BASKET DIVIDER

SCA240

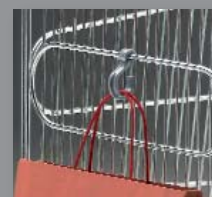

GANCHO CUELGA BOLSOS
PLASTIC BAG HOOK

GCBCA

CARRO FRONTAL ABATIBLE

EASY CHECK-OUT TROLLEY



200 L.



200 L.

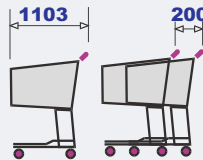
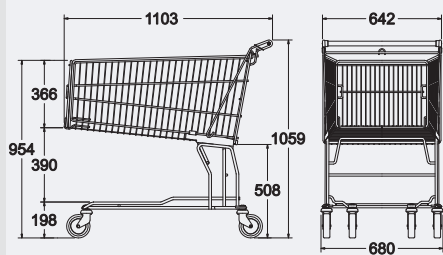

- x5** 1,83 mts.
- x10** 2,83 mts.
- x15** 3,83 mts.
- x25** 5,83 mts.

CODIFICACION BASICA DEL CARRO DE AUTOSERVICIO

SUPERMARKET TROLLEY CODES

PORTA-BEBE
BABY SEAT

SIN
WITHOUT



CON
WITH



CASSPAF203
29,3 kg.



CASSPAF206
29,3 kg.



CASSPAF207
29,8 kg.



CASSPAF208
29,1 kg.

CASCPAF203
30,8 kg.

CASCPAF206
30,8 kg.

CASCPAF207
31,3 kg.

CASCPAF208
30,6 kg.

EUROLOC MANGO REDONDO
EUROLOC FOR ROUND HANDLE
MCSEURR

VARILOC
MCVH



EUROLOC MANGO OVAL
EUROLOC FOR OVAL HANDLE
MCSEURO



SMARTLOC
MDCS

CADENA INICIAL 1 mts.
STARTING CHAIN 1 mts.
CI-S1



MANGO ERGOBOX ERGOBOX HANDLE
MEBM



SOPORTE SCANNER DE MANO "ERGOBOX"
SCANNER HOLDER FOR "ERGOBOX"
SSE

LUPA PLEGABLE "ERGOBOX"
MAGNIFYING GLASS
LPMEBX



PROMOBOX MANGO REDONDO
PROMOBOX FOR ROUND HANDLE
PMMR

PROMOBOX MANGO OVAL
PROMOBOX FOR OVAL HANDLE
PMMO

ORIGINAL PARA REPRODUCCION
ORIGINAL FOR CUSTOMIZED HANDLE
ORL

LOGOTIPO PARA MANGO
CUSTOMIZED HANDLE
LMC



ORIGINAL PARA REPRODUCCION "ERGOGRIP"
ORIGINAL CUSTOMIZED HANDLE FOR "ERGOGRIP"
ORL-E

LOGOTIPO PARA MANGO "ERGOGRIP"
CUSTOMIZED HANDLE FOR "ERGOGRIP"
LMC-E

RAL 3011 RAL 1028 RAL 5005 RAL 7001 RAL 3020



RAL 6028 RAL 2004 RAL 1023 NEGRO-BLACK RAL 6018



SOPORTE SCANNER INDIVIDUAL
SINGLE SCANNER HOLDER
SSIND



GANCHO CUELGA BOLSOS
PLASTIC BAG HOOK
GBCA



CUNA DE CESTO
BABY CRADLE
CCB



PORTA-BEBE
DOBLE FUNCION **PBPDF**



DOUBLE FUNCTION
BABY SEAT



REJILLA DE PLATAFORMA
GRILL BASE
RPCA140

COLOR PARA CARRO
AVAILABLE PAINTED COLOURS



PERFECTO SISTEMA DE
ACOPLAMIENTO ENTRE CARROS
PERFECT FACING JOINT



CONCEPTO DE COBRO "CARRO A CARRO"
SPECIALLY INDICATED FOR "TROLLEY BY TROLLEY"
CHECK-OUT SYSTEM

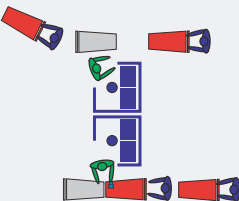

FACIL APERTURA
DE LA REJILLA FRONTAL
EASY FRONT OPENING



CARRO SKALATOR

SKALATOR TROLLEY



120 L.



140 L.

120 L.

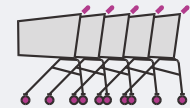
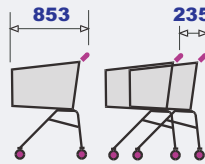

- x5** 1,79 mts.
- x10** 2,97 mts.
- x15** 4,14 mts.
- x25** 6,49 mts.

140 L.

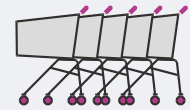
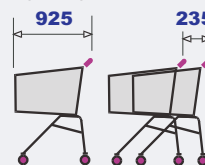

- x5** 1,87 mts.
- x10** 3,04 mts.
- x15** 4,22 mts.
- x25** 6,57 mts.

CODIFICACION BASICA DEL CARRO DE AUTOSERVICIO

SUPERMARKET TROLLEY CODES

PORTA-BEBE
BABY SEAT

SIN
WITHOUT

CON
WITH

CAK0012003
18,45 kg.

CAPK012003
19,95 kg.



CAK0014003
19,65 kg.

CAPK014003
21,15 kg.

PORTA-BEBE
BABY SEAT

SIN
WITHOUT

CON
WITH

120 L.

140 L.

EUROLOC MANGO REDONDO
EUROLOC FOR ROUND HANDLE
MCSEURR

VARILOC
MCVH



EUROLOC MANGO OVAL
EUROLOC FOR OVAL HANDLE
MCSEURO



SMARTLOC
MDCS

CADENA INICIAL 1 mts.
STARTING CHAIN 1 mts.
CI-S1



MANGO ERGOBOX
MEBM

SOLO PARA 140 L.
ONLY 140 L.



SOPORTE SCANNER DE MANO "ERGOBOX"
SCANNER HOLDER FOR "ERGOBOX"
SSE

LUPA PLEGABLE "ERGOBOX"
MAGNIFYING GLASS
LPMEBX



PROMOBOX MANGO REDONDO
PROMOBOX FOR ROUND HANDLE
PMMR

PROMOBOX MANGO OVAL
PROMOBOX FOR OVAL HANDLE
PMMO

ORIGINAL PARA REPRODUCCION
ORIGINAL FOR CUSTOMIZED HANDLE
ORL

LOGOTIPO PARA MANGO
CUSTOMIZED HANDLE
LMC



ORIGINAL PARA REPRODUCCION "ERGOGRIIP"
ORIGINAL CUSTOMIZED HANDLE FOR "ERGOGRIIP"
ORL-E

LOGOTIPO PARA MANGO "ERGOGRIIP"
CUSTOMIZED HANDLE FOR "ERGOGRIIP"
LMC-E

RAL 3011 RAL 1028 RAL 5005 RAL 7001 RAL 3020



RAL 6028 RAL 2004 RAL 1023 NEGRO-BLACK RAL 6018

SOPORTE SCANNER INDIVIDUAL
SINGLE SCANNER HOLDER
SSIND



PORTACARTEL PUBLICITARIO
ADVERTISEMENT HOLDER
PCPCA80160



CUNA DE CESTO
BABY CRADLE
CCBD

TUBO DE ARRASTRE "SKALATOR"
"SKALATOR" DRAG PIPE
TASK



COLOR PARA CARRO
AVAILABLE PAINTED COLOURS



PORTA-BEBE
DOBLE FUNCION
PBPDFI

SOLO PARA 140 L. ONLY 140 L.



DOUBLE FUNCTION
BABY SEAT



CONJUNTO PROTECCION CESTO
BASKET PROTECTOR SET
CPC120
CPC140



CANTONERAS
CORNER PROTECTORS
CPEC



SEPARADOR CESTA PEQUEÑO
BASKET DIVIDER
SPCA120
SPCA140



SEPARADOR CESTA
VERTICAL BASKET DIVIDER
SCA120
SCA140



GANCHO CUELGA BOLSOS
PLASTIC BAG HOOK
GCBCA

CARRO PLATAFORMA GRAN CARGA

STANDARD TROLLEY FOR CRATES

150 L.



LA ALTURA ENTRE PLATAFORMA Y CESTO PERMITE UNA GRAN CAPACIDAD DE CARGA TANTO PARA ENVASES DE 1,5 LITROS COMO PARA CARGAS DE GRAN VOLUMEN.

THE BASKET HAS BEEN SPECIALLY DEVELOPED SO THE TROLLEY PLATFORM CAN CARRY CRATES OF 1'5 LITRE BOTTLES AND BIG VOLUMEN PACKAGES.

150 L.

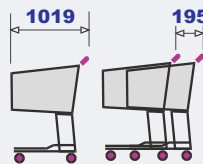
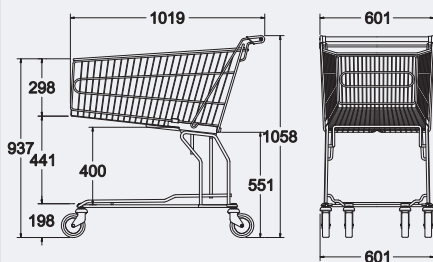

- x5** 1,80 mts.
- x10** 2,77 mts.
- x15** 3,75 mts.
- x25** 5,70 mts.

CODIFICACION BASICA DEL CARRO DE AUTOSERVICIO

SUPERMARKET TROLLEY CODES

PORTA-BEBE
BABY SEAT

SIN
WITHOUT



CON
WITH



3

CASGCS1503
25,65 kg.



6

CASGCS1506
25,85 kg.



7

CASGCS1507
26,25 kg.



8

CASGCS1508
25,65 kg.

CASGCP1503
27,15 kg.

CASGCP1506
27,35 kg.

CASGCP1507
27,75 kg.

CASGCP1508
27,15 kg.

VARILOC
MCVH



SMARTLOC
MDCS

EUROLOC MANGO REDONDO
EUROLOC FOR ROUND HANDLE
MCSEURR



EUROLOC MANGO OVAL
EUROLOC FOR OVAL HANDLE
MCSEURO



CADENA INICIAL 1 mts.
STARTING CHAIN 1 mts.
CI-S1



MANGO ERGOBOX ERGOBOX HANDLE
MEBM



SOPORTE SCANNER DE MANO "ERGOBOX"
SCANNER HOLDER FOR "ERGOBOX"

SSE

LUPA PLEGABLE "ERGOBOX"
MAGNIFYING GLASS
LPMEBX



PROMOBX MANGO REDONDO
PROMOBX FOR ROUND HANDLE

PMMR

PROMOBX MANGO OVAL
PROMOBX FOR OVAL HANDLE

PMMO

ORIGINAL PARA REPRODUCCION
ORIGINAL FOR CUSTOMIZED HANDLE
ORL
LOGOTIPO PARA MANGO
CUSTOMIZED HANDLE
LMC



ORIGINAL PARA REPRODUCCION "ERGOGRIP"
ORIGINAL CUSTOMIZED HANDLE FOR "ERGOGRIP"

ORL-E

LOGOTIPO PARA MANGO "ERGOGRIP"
CUSTOMIZED HANDLE FOR "ERGOGRIP"
LMC-E

RAL 3011



RAL 1028



RAL 5005



RAL 7001



RAL 3020



RAL 6028



RAL 2004



RAL 1023



NEGRO-BLACK



RAL 6018

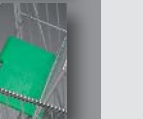

SOPORTE SCANNER INDIVIDUAL
SINGLE SCANNER HOLDER

SSIND



PORTACARTEL PUBLICITARIO
ADVERTISEMENT HOLDER
PCPCA80160



CUNA DE CESTO
BABY CRADLE

CCBD



PORTA-BEBE
DOBLE FUNCION

PBPDFI

DOUBLE FUNCTION
BABY SEAT



REJILLA DE PLATAFORMA
GRILL BASE

RPCA150



COLOR PARA CARRO
AVAILABLE PAINTED COLOURS



SEPARADOR CESTA PEQUEÑO
BASKET DIVIDER

SPCA150



SEPARADOR CESTA
VERTICAL BASKET DIVIDER

SCA150



GANCHO CUELGA BOLSOS
PLASTIC BAG HOOK

GCBCA



CONJUNTO PROTECCION CESTO
BASKET PROTECTOR SET

CPC150



CANTONERAS
CORNER PROTECTORS

CPEC

CARRO BASE DE CESTA ELEVADA

ANTI-THEFT TROLLEY COMFORT BASKET

150 L.



LA ALTURA ESPECIAL DEL CESTO PERMITE MAYOR COMODIDAD EN LA CARGA Y RECOGIDA DEL PRODUCTO, FACILITANDO EL PROCESO DE COMPRA Y COBRO EN LA LINEA DE CAJAS.

TROLLEY SPECIALLY DESIGNED FOR A FRIENDLY CUSTOMER-ORIENTED USE. THE BASKET ERGONOMY IS DEVELOPED TO FACILITATE THE LOADING OF THE TROLLEY AS WELL AS THE CHECK OUT PROCESS.

150 L.

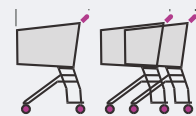
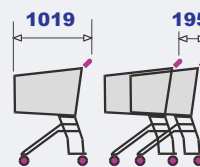

- x5** 1,80 mts.
- x10** 2,77 mts.
- x15** 3,75 mts.
- x25** 5,70 mts.

CODIFICACION BASICA DEL CARRO DE AUTOSERVICIO

SUPERMARKET TROLLEY CODES

PORTA-BEBE
BABY SEAT

SIN
WITHOUT



CON
WITH



3

CAACES1503
25,50 kg.



6

CAACES1506
25,70 kg.



7

CAACES1507
26,10 kg.



8

CAACES1508
25,50 kg.

CAACEP1503
27,00 kg.

CAACEP1506
27,20 kg.

CAACEP1507
27,6 kg.

CAACEP1508
27,00 kg.

VARILOC
MCVH



SMARTLOC
MDCS

EUROLOC MANGO REDONDO
EROLOC FOR ROUND HANDLE
MCSEURR

EUROLOC MANGO OVAL
EROLOC FOR OVAL HANDLE
MCSEURO



CADENA INICIAL 1 mts.
STARTING CHAIN 1 mts.

CI-S1



MANGO ERGOBOX ERGOBOX HANDLE
MEBM



SOPORTE SCANNER DE MANO "ERGOBOX"
SCANNER HOLDER FOR "ERGOBOX"

SSE

LUPA PLEGABLE "ERGOBOX"
MAGNIFYING GLASS

LPMEBX



PROMOBOX MANGO REDONDO
PROMOBOX FOR ROUND HANDLE

PMMR

PROMOBOX MANGO OVAL
PROMOBOX FOR OVAL HANDLE

PMMO

ORIGINAL PARA REPRODUCCION
ORIGINAL FOR CUSTOMIZED HANDLE

ORL

LOGOTIPO PARA MANGO
CUSTOMIZED HANDLE

LMC



ORIGINAL PARA REPRODUCCION "ERGOGRIP"
ORIGINAL CUSTOMIZED HANDLE FOR "ERGOGRIP"

ORL-E

LOGOTIPO PARA MANGO "ERGOGRIP"
CUSTOMIZED HANDLE FOR "ERGOGRIP"

LMC-E

RAL 3011

RAL 1028

RAL 5005

RAL 7001

RAL 3020

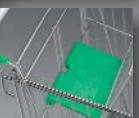
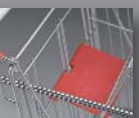

RAL 6028

RAL 2004

RAL 1023

NEGRO-BLACK

RAL 6018



SOPORTE SCANNER INDIVIDUAL
SINGLE SCANNER HOLDER

SSIND



CUNA DE CESTO
BABY CRADLE

CCBD



COLOR PARA CARRO
AVAILABLE PAINTED COLOURS



PORTACARTEL PUBLICITARIO
ADVERTISEMENT HOLDER

PCPCA80160



PORTA-BEBE
DOBLE FUNCION

PBPDFI

DOUBLE FUNCTION
BABY SEAT



CONJUNTO PROTECCION CESTO
BASKET PROTECTOR SET

CPC150



CANTONERAS
CORNER PROTECTORS

CPEC

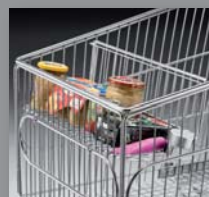

SEPARADOR CESTA PEQUEÑO
BASKET DIVIDER

SPCA150



SEPARADOR CESTA
VERTICAL BASKET DIVIDER

SCA150

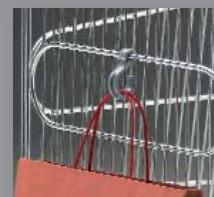

GANCHO CUELGA BOLSOS
PLASTIC BAG HOOK

GCBCA

CARRO DE COMPRA LIGERA

LIGHT SHOPPING TROLLEY



80 L.

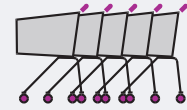
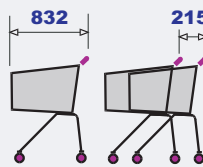
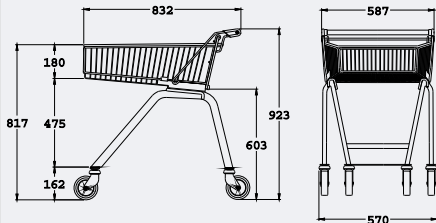

- x5** 1,69 mts.
- x10** 2,77 mts.
- x15** 3,84 mts.
- x25** 5,99 mts.

100 L.

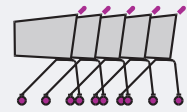
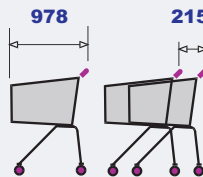
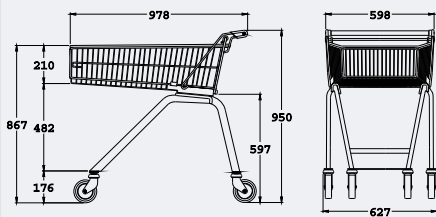

- x5** 1,83 mts.
- x10** 2,91 mts.
- x15** 3,98 mts.
- x25** 6,13 mts.

CODIFICACION BASICA DEL CARRO DE AUTOSERVICIO

SUPERMARKET TROLLEY CODES



80 L.

CCLSP08003
18,70 kg.

CCLSP08006
18,80 kg.

CCLSP08007
19,20 kg.

CCLSP08008
18,70 kg.

100 L.

CCLSP010003
18,45 kg.

CCLSP010006
18,65 kg.

CCLSP010007
19,05 kg.

CCLSP010008
18,45 kg.



MANGO ERGOBOX ERGOBOX HANDLE
MEBM



SOPORTE SCANNER DE MANO "ERGOBOX"
SCANNER HOLDER FOR "ERGOBOX"

SSE
LUPA PLEGABLE "ERGOBOX"
MAGNIFYING GLASS
LPMEBX

EUROLOC MANGO REDONDO
EUROLOC FOR ROUND HANDLE
MCSEURR

VARILOC
MCVH

EUROLOC MANGO OVAL
EUROLOC FOR OVAL HANDLE
MCSEURO



SMARTLOC
MDCS



CADENA INICIAL 1 mts.
STARTING CHAIN 1 mts.
CI-S1

ORIGINAL PARA REPRODUCCION
ORIGINAL FOR CUSTOMIZED HANDLE

ORL

LOGOTIPO PARA MANGO
CUSTOMIZED HANDLE
LMC



ORIGINAL PARA REPRODUCCION "ERGOGRIP"
ORIGINAL CUSTOMIZED HANDLE FOR "ERGOGRIP"

ORL-E

LOGOTIPO PARA MANGO "ERGOGRIP"
CUSTOMIZED HANDLE FOR "ERGOGRIP"
LMC-E



PROMOBOX MANGO REDONDO
PROMOBOX FOR ROUND HANDLE

PMMR

PROMOBOX MANGO OVAL
PROMOBOX FOR OVAL HANDLE

PMMO

RAL 3011

RAL 1028

RAL 5005

RAL 7001

RAL 3020



RAL 6028

RAL 2004

RAL 1023

NEGRO-BLACK

RAL 6018



SOPORTE SCANNER INDIVIDUAL
SINGLE SCANNER HOLDER

SSIND



CONJUNTO PROTECCION CESTO
BASKET PROTECTOR SET

CPC80
CPC100



CANTONERAS
CORNER PROTECTORS

CPEC



COLOR PARA CARRO
AVAILABLE PAINTED COLOURS

CARRO "E-M"

"E-M" TROLLEY

140 L.



CARRO DISEÑADO PARA SU UTILIZACION EN ESCALERAS MECANICAS

TROLLEY SPECIALLY DESIGNED TO BE USED ON AUTOMATIC STAIRS SYSTEMS

140 L.

LIMITE DE CARGA
MAXIMUM LOAD

50 KG.

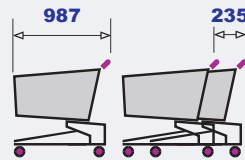
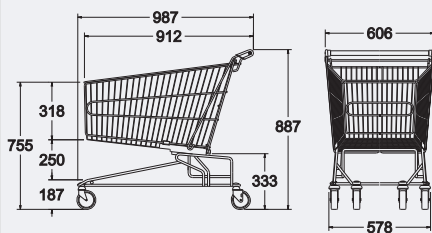

- x5** 1,93 mts.
- x10** 3,10 mts.
- x15** 4,28 mts.
- x25** 6,63 mts.

CODIFICACION BASICA DEL CARRO DE AUTOSERVICIO

SUPERMARKET TROLLEY CODES



CAEM1406-7
26,0 kg.



CAEM1407-8
26,0 kg.

EUROLOC MANGO REDONDO
EROLOC FOR ROUND HANDLE
MCSEURR

VARILOC
MCVH



SMARTLOC
MDCS

EUROLOC MANGO OVAL
EROLOC FOR OVAL HANDLE
MCSEURO



CADENA INICIAL 1 mts.
STARTING CHAIN 1 mts.
CI-S1



MANGO ERGOBOX ERGOBOX HANDLE
MEBM



SOPORTE SCANNER DE MANO "ERGOBOX"
SCANNER HOLDER FOR "ERGOBOX"

SSE

LUPA PLEGABLE "ERGOBOX"
MAGNIFYING GLASS
LPMEBX

ORIGINAL PARA REPRODUCCION
ORIGINAL FOR CUSTOMIZED HANDLE

ORL
LOGOTIPO PARA MANGO
CUSTOMIZED HANDLE
LMC



ORIGINAL PARA REPRODUCCION "ERGOGRIP"
ORIGINAL CUSTOMIZED HANDLE FOR "ERGOGRIP"

ORL-E

LOGOTIPO PARA MANGO "ERGOGRIP"
CUSTOMIZED HANDLE FOR "ERGOGRIP"
LMC-E

RAL 3011

RAL 1028

RAL 5005

RAL 7001

RAL 3020



RAL 6028

RAL 2004

RAL 1023

NEGRO-BLACK

RAL 6018



SOPORTE SCANNER INDIVIDUAL
SINGLE SCANNER HOLDER

SSIND

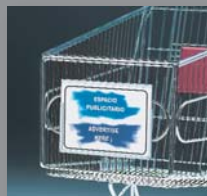

PORTACARTEL PUBLICITARIO
ADVERTISEMENT HOLDER
PCPCA80160

PROMOBBOX MANGO REDONDO
PROMOBBOX FOR ROUND HANDLE

PMMR

PROMOBBOX MANGO OVAL
PROMOBBOX FOR OVAL HANDLE

PMMO



COLOR PARA CARRO
AVAILABLE PAINTED COLOURS



PORTA-BEBE
DOBLE FUNCION

PBPDFI



DOUBLE FUNCTION
BABY SEAT



CONJUNTO PROTECCION CESTO
BASKET PROTECTOR SET

CPC140



CANTONERAS
CORNER PROTECTORS
CPEC



SEPARADOR CESTA PEQUEÑO
BASKET DIVIDER

SPCA140



SEPARADOR CESTA
VERTICAL BASKET DIVIDER

SCA140

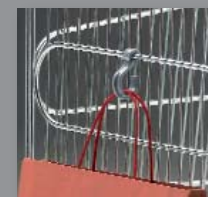

GANCHO CUELGA BOLSOS
PLASTIC BAG HOOK

GCBCA

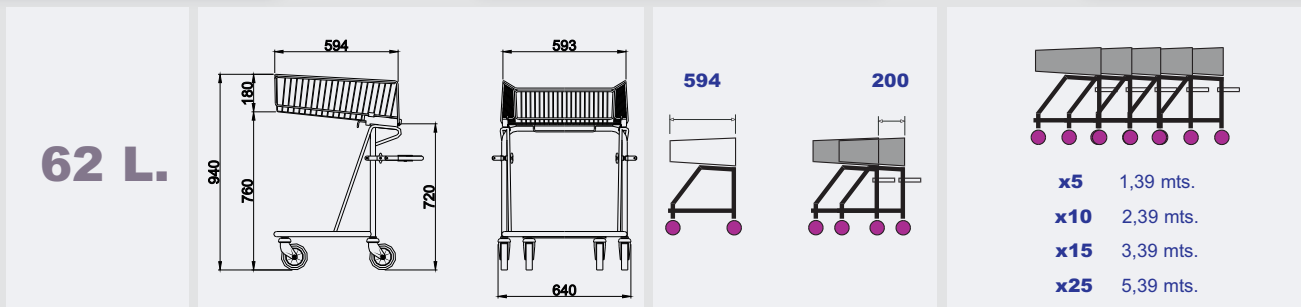

CODIFICACION BASICA DEL CARRO DE AUTOSERVICIO

SUPERMARKET TROLLEY CODES



CAMV6203
14,45 kg.



CAMV6206
14,65 kg.



CAMV6207
15,05 kg.



CAMV6208
14,45 kg.